

BExCA110-05D & BExDCA110-05D ATEX EEx Combined Voice Sounder & Beacon



- CA110-05D : EEx d IIB T4 (Tamb. -50 to +55°C)
- ATEX / CENELEC / FTZU / GOST R
- Voltages : 24vdc;115vac;230vac

Sounder.

- Nominal output : 110dB(A) @ 1m +/- 3dB - Tone 5.
- 10 alarm tones (including silence to allow speech only option) UKOOA / PFEER compliant.
- Edits automatically to message length.
- Easy message creation with built in microphone.
- Volume control.
- DC versions have reverse polarity protection.
- 100m effective range @ 1kHz.
- Negative or positive remote switching.

Beacon.

- 5 Joule Xenon : 1Hz (60 FPM) (5 Ws).
- Six lens colours available : Amber, Blue, Clear, Green, Red & Yellow
- Automatic synchronisation on multi-beacon systems
- Beacons can be set to 'flip-flop' alternating mode with other units on multi-beacon systems
- Tube life : emissions reduced to 70% after 8 million flashes
- Xenon tubes mechanically secured against shock/vibration

- CA110-05D : IP67
- Enclosure material : Marine grade LM6 Aluminium
- Chromated & powder coated finish - good resistance to humidity and salt spray environments.
- BExCA110-05D Horn : High impact UL94 V0 & 5VA FR ABS
- BExCA110-05D Horn : Anti-Static High impact ABS
- Colour available : Red (RAL3000)
- Operating temperature : -50 to +55°C
- Storage temperature : -50 to +70°C
- Large range of certified end of line resistors.
- Weight : DC:4.80kg AC: 5.00kg
- KEMA Certificate number : 01ATEX2223



BExCA110-05D

Flameproof combination voice sounders & beacons
Zones 1 & 2
⊕ II 2G EEx d IIB T4

BExDCA110-05D

Flameproof & Dust ignition proof combination voice sounders & beacons
Zones 1, 2, 21 & 22
⊕ II 2GD EEx d IIB T4 T100°C

The sounder records, stores and plays back user defined messages stored directly to non-volatile memory without any intermediate analogue to digital conversion.

A single 16 second, message may be recorded and played back with a choice of 1 of 10 user selectable alarm tones (including silence to allow speech only option).

Installation Features.

- Very large termination area.
- Dual M20 ISO cable gland entries (supplied with one stopping plug).
- Ratchet adjustable stainless steel 'U' bracket for positive adjustment under harsh conditions.
- IN & OUT terminals
- Terminals accept 0.5 to 4.0mm² cables.
- Line monitoring : Min. 500 Ohm 2w, or 3k3 Ohm 0.5w resistor, or diode within EExd enclosure (dc versions)
- Sounder & beacon may be connected from a single supply for simultaneous operation or from separate supplies for independent operation.

Input voltages and current consumption for the voice sounder component:

Voltage :	24vdc	115vac	230vac
		50/60Hz	50/60Hz
Voltage range :	+/-25%	+/-10%	+/-10%
Current mA :	480mA	90mA	45mA





Input voltages and current consumption for the beacon component:

Voltage :	24vdc	115vac	230vac
		50/60Hz	50/60Hz
Voltage range :	20-28v	+/-10%	+/-10%
Current mA :	270mA	140mA	55mA

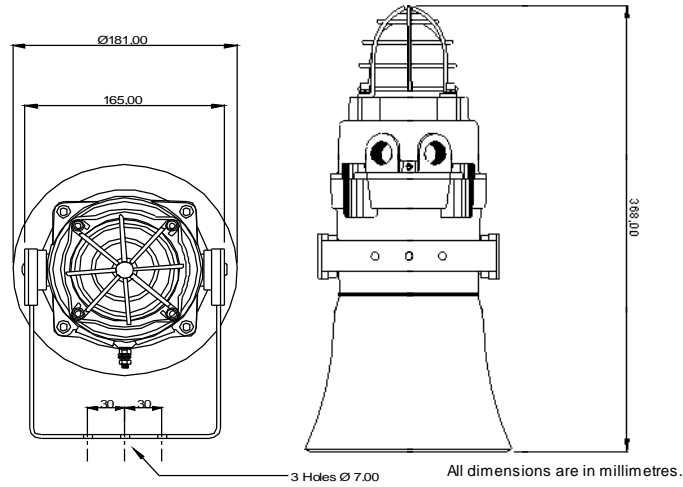
Also available :

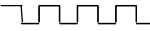
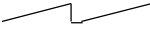
- BExS110 & S120 EEx d & EEx de sounder units with output levels of 117dB(A)
- Programmable versions with 45 tones and 4 stages.
- BExA110 & A120 EEx d & EEx de Voice Annunciation units.
- BExBG EEx d & EEx de 5, 10 & 15 Joule Xenon beacons
- BExL15 & 25 watt EEx d & EEx de loudspeakers.
- BExTS110 & BExTBG05 EEx d Telephone ringers and beacons.

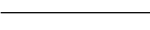

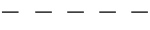
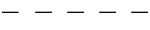
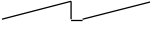
Stage 1	Frequency Description	Cycles
Tone 1	800/1000Hz @ 0.25 sec Alternating	 4 cycles
Tone 2	500/1200Hz @ 0.3Hz 0.5 sec Slow Whoop	 2 cycles
Tone 3	1200/500Hz @ 1Hz - DIN / PFEER P.T.A.P.	 4 cycles
Tone 4	544Hz (100mS)/440Hz (400mS) - NF S 32-001	 4 cycles
Tone 5	1000Hz Continuous - PFEER Toxic Gas	 2 cycles
Tone 6	Bell	 2 cycles
Tone 7	1KHz 1s on, 1s off Intermittent - PFEER Gen. Alarm	 3 cycles
Tone 8	420Hz @ 0.625 sec Australian Alert	 4 cycles
Tone 9	500-1200Hz 3.75sec /0.25sec. Australian Evac.	 2 cycles
Tone 10	No tone - 0.5 second gap	

Ordering code : **BExCA110-05D** **24** **DC** - **AM**

Product	Voltage	Supply	Lens
BExCA110-05D	24	DC	AM Amber
BExDCA110-05D	115	AC	BL Blue
	230		CL Clear
			GN Green
			RD Red
			YW Yellow

N.B IMPORTANT NOTICE : THE BExCS110-05D, BExCA110-05D, BExCL15-05D, BExCBG05-05D ARE NOT FOR SALE, RE-SALE, INSTALLATION, OR USE WITHIN THE UNITED STATES OF AMERICA AS A SOLE, MULTIPLE, INTEGRATED, OR INCORPORATED UNIT.